

ORTHOPANTOMOGRAPH™ OP 3D™ PRO

A platform for changing needs



ORTHOPANTOMOGRAPH OP 3D PRO

The OP 3D Pro system is the most comprehensive 3-in-1 platform designed for today and tomorrow, covering the entire maxillofacial region. The OP 3D Pro system combines an advanced panoramic imaging system with either cephalometric or cone beam 3D or a combination of both, giving you a truly adaptable platform.

With OP 3D Pro units, each feature is optimized to provide the best possible image quality and efficient clinical use. OP 3D Pro units master the details.

OP 3D PRO

Complete versatility

ORTHOPANTOMOGRAPH OP 3D Pro units are a platform for changing needs. Depending on the configuration, OP 3D Pro units can be upgraded with CBCT or cephalometric modalities.

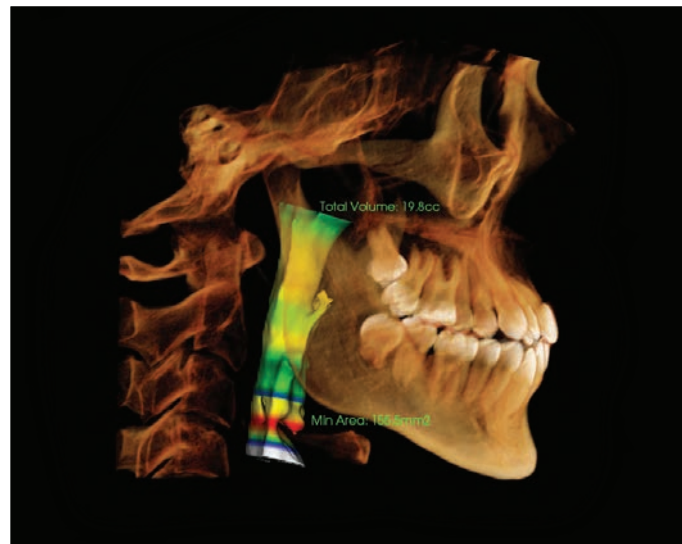

Excellence for all clinical needs

- General Practitioners
- Endodontics
- Implantology
- Orthodontics
- Oral & Maxillofacial Surgery
- Periodontics
- Prosthodontics
- Airway

Control without compromise

With ORTHOPANTOMOGRAPH units, no usability compromises have been made. The OP 3D Pro system offers ultimate control for obtaining diagnostic information from the correct region of interest. This is achieved with the optimum combination of patient positioning and SMARTVIEW™ scout image.

SMARTVIEW image functionality

SMARTVIEW image functionality FOV positioning accuracy can be verified or adjusted if needed by taking SMARTVIEW scout image before CBCT examination. Furthermore, the FOV can be positioned freely to the region of interest, both in horizontal and vertical directions—with ease and confidence.

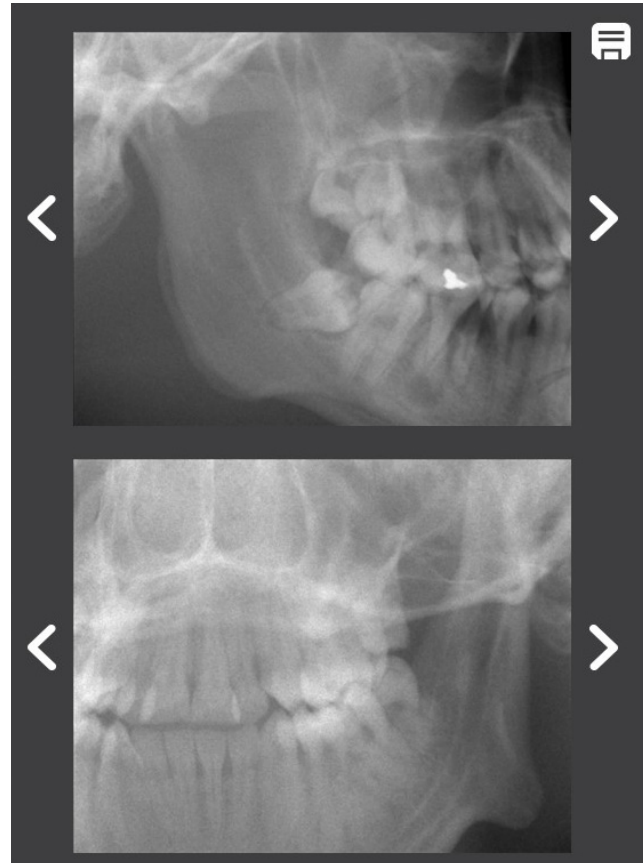

Even the smallest FOV can be efficiently and precisely positioned with the help of the intuitive user interface and SMARTVIEW functionality.

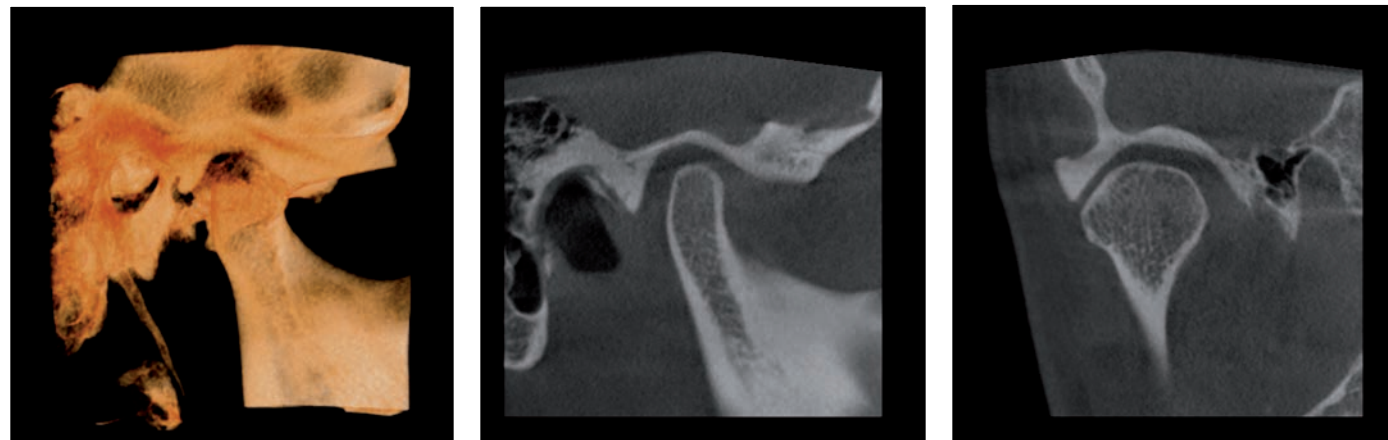

User-experience in focus

The large, easy-to-use, 10" user interface enables intuitive usage and setting of imaging parameters from the very beginning. The result is fast and effortless workflow for all modalities.



Precision for every patient

3D images provide valuable information vital to diagnosis and determining the best course of treatment. Evaluation of different morphologies is easy as the region of interest can be viewed from all directions.

The precision of the OP 3D Pro system is founded on the carefully optimized image quality parameters of each program. Both the volume and the resolution can be selected according to the indication and region of interest. The OP 3D Pro system provides dental professionals with the tools to succeed.



Automatic dose control for 3D

With the proprietary ADC feature, patient-specific exposure settings are obtained automatically providing premium quality images at the optimal dose for the patient.

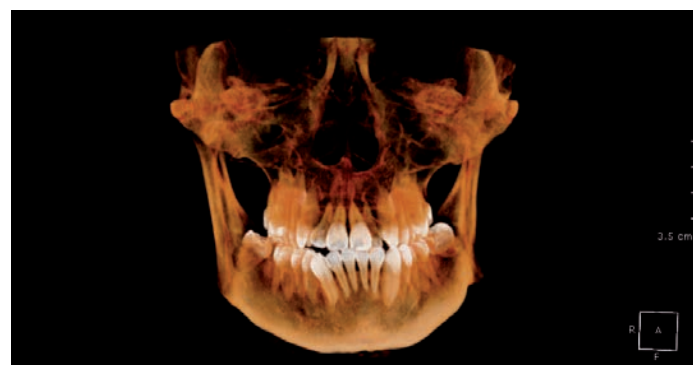

Resolution for each indication

For each FOV size, it is possible to choose between different resolutions. Additionally, the user selectable Metal Artifact Reduction (MAR) tool can be used with every available FOV.

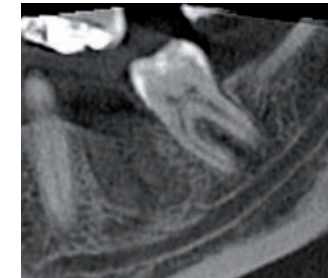

Low Dose Technology™ scan (LDT) scan can be utilized in dose sensitive cases and control or follow-up situations where lower resolution is acceptable.

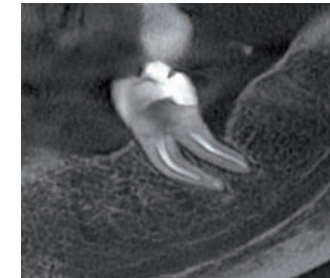

Standard resolution scan with optimized patient dose can be used for general diagnostics.

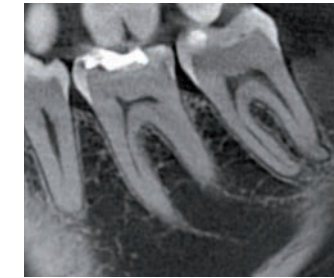

High resolution scan offers extremely sharp images for more detailed diagnosis.

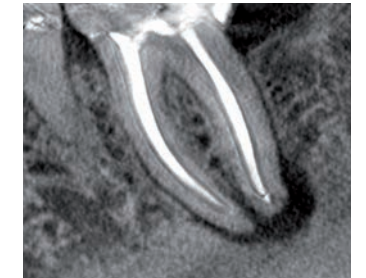

Endo resolution scan 85 μm voxel size with MAR tool specially designed for endodontic applications. Endo resolution is available for the smallest FOV.

Image quality and patient dose optimized—in all OP 3D Pro programs

80%

Dose Reduction with Low Dose Technology

OP 3D Pro users have the luxury of using Low Dose Technology (LDT), which provides quality optimized low dose scans at up to an 80% reduction in dosing compared to the standard 3D acquisition protocol* while keeping the clinical value still intact.

*OP300 Maxio (OP 3D Pro) Dosimetry report, Prof. John B. Ludlow, April 2014.



OP 3D PRO

FOV 5x5 cm

Optimized for single-site implants or localized diagnostics, keeping the patient dose at a substantially reduced level.



FOV 8x15 cm

Covers both mandibula and maxilla including airway and upper cervical spine or the sinus. Both TM joints can also be studied.



FOV 6x8 cm

Covers the complete dental arch for multiple implant placement and allows for the use of surgical guides.



FOV 13x15 cm

Covers the entire maxillofacial region.



FOV 8x8 cm

Covers the entire dentition, including both mandibula and maxilla as well as a portion of maxillary sinus.



Clinical images

FOV 13x15 cm

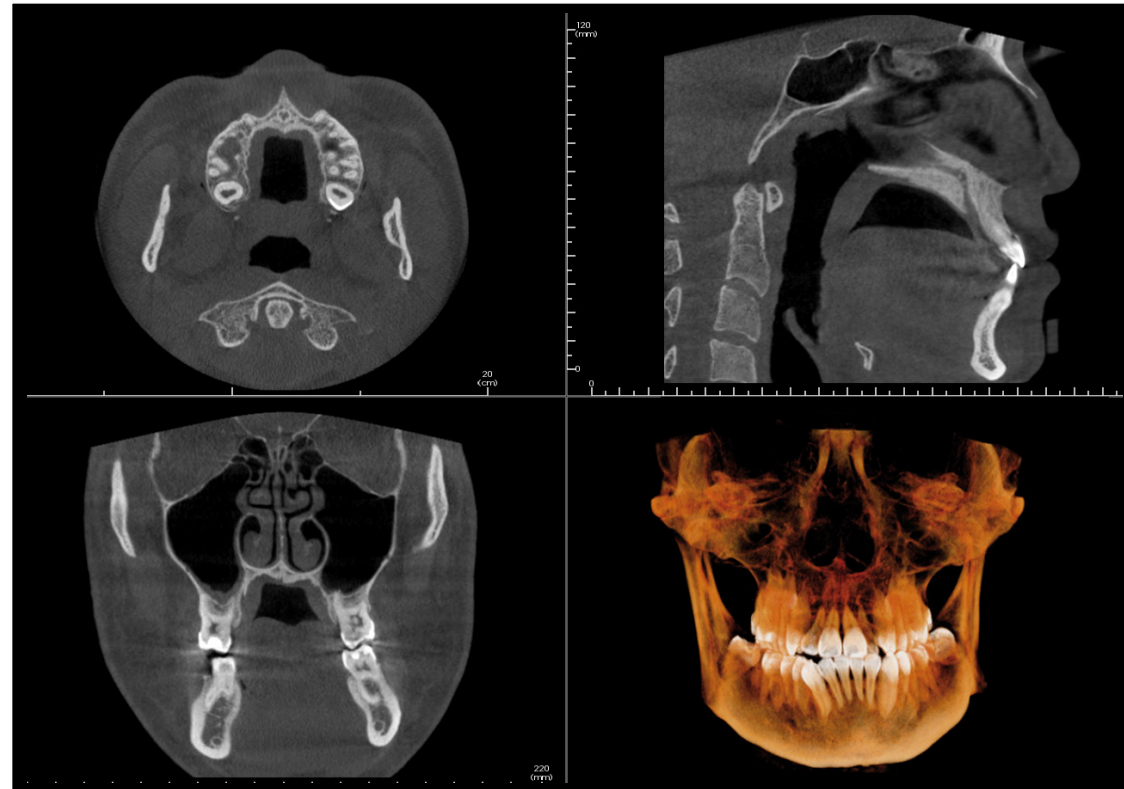

FOV 8x15 cm

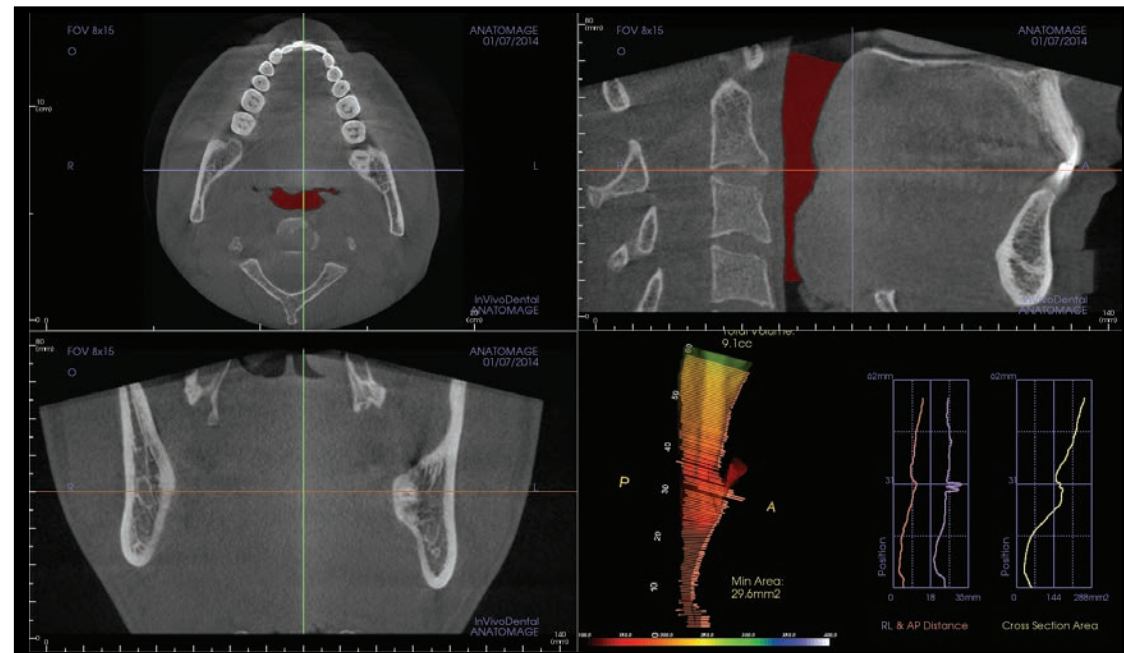

FOV 8x8 cm

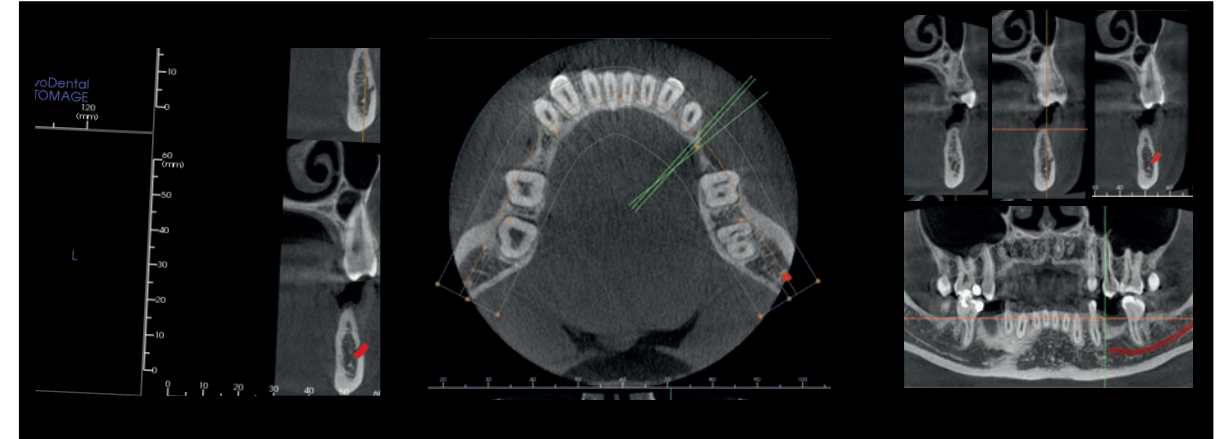

FOV 6x8 cm

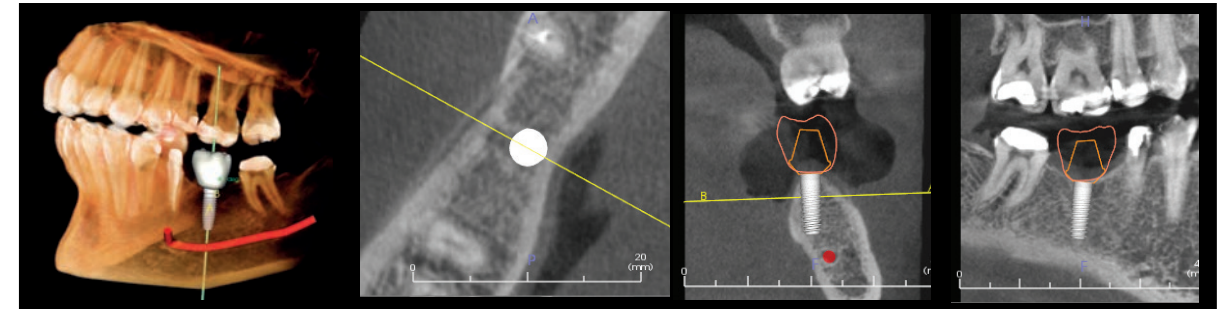

FOV 5x5 cm

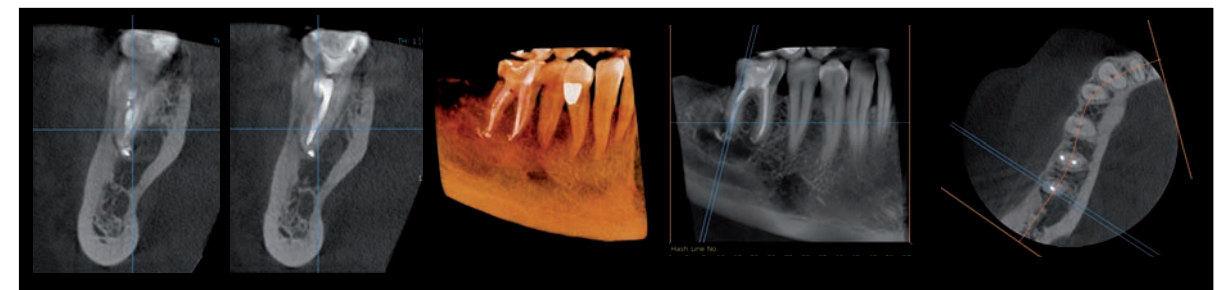

OP 3D Pro panoramic: **Perfection brings confidence**

Consistent, repeatable, gold-standard image quality offers the power to diagnose quickly and efficiently with a wide range of panoramic imaging programs. The unique combination of a dedicated panoramic sensor, ADC, easy patient positioning and the best possible imaging geometry provide excellent diagnostic images—time after time.

Automatic dose control (ADC)

Proprietary ADC technology automatically optimizes panoramic exposure levels for each patient and every acquisition, resulting in patient-specific dosage and enhanced workflow efficiency.

Multilayer pan

The OP 3D Pro multilayer feature provides five panoramic images with only one scan to compensate for incorrect patient positioning and difficult anatomies—all achieved in the same scanning time and dose as the traditional panoramic scan.

ORTHOfocus™ feature—sharp images automatically

With the user-selectable ORTHOfocus™ feature, an optimum panoramic layer is provided automatically and every time.

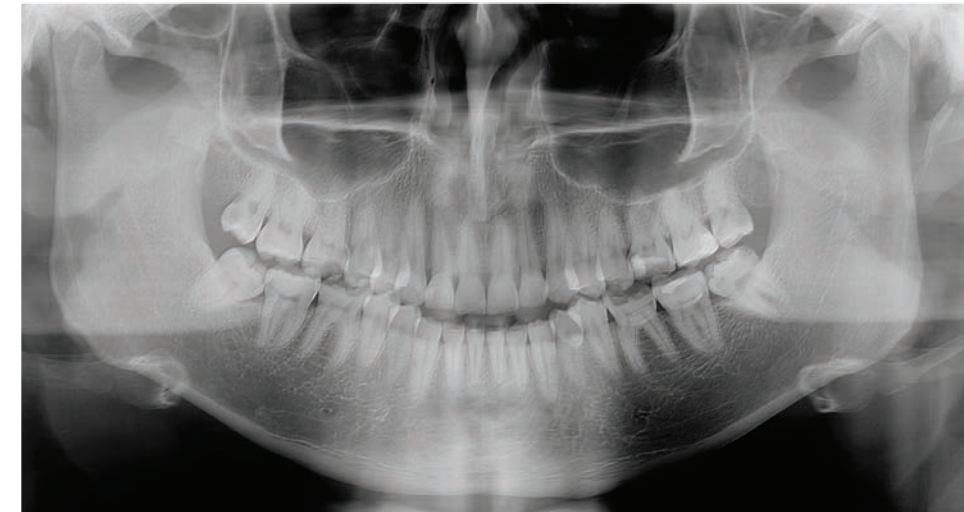

The standard adult panoramic imaging program provides a clear and consistent image.



The pediatric panoramic program has a clinically adapted image layer and reduced images height.

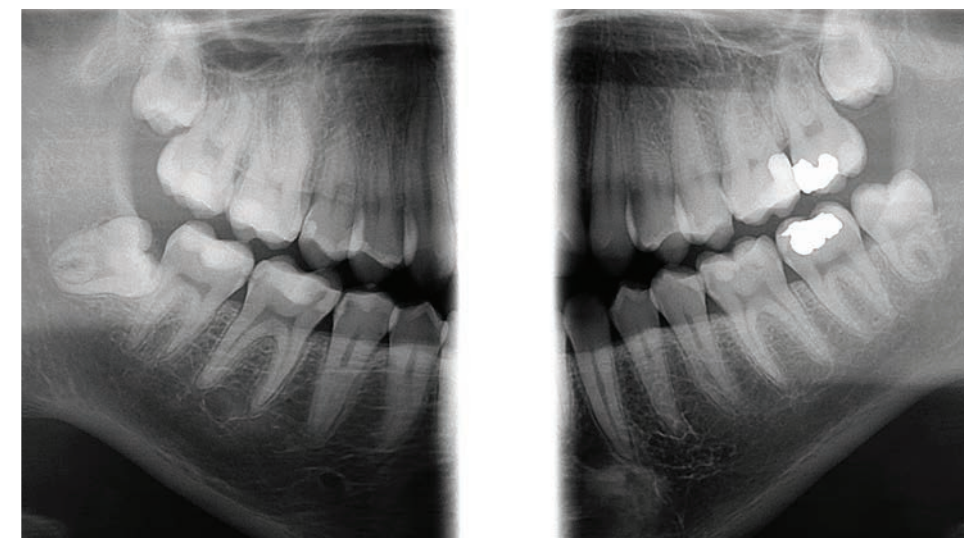

The bitewing-like view is a quick and easy alternative to an intraoral bitewing imaging.

OP 3D PRO cephalometric: **Unsurpassed results**

A variety of cephalometric imaging programs are available for OP 3D Pro units. Furthermore, it can be tailored to your preferences. The cephalometric arm can be positioned to either side for optimum use of space and user-experience.

Excellent image quality for every patient

Automatic Facial Contour (AFC) automatically decreases the exposure values during the scan for better soft tissue definition in the facial region.

Adjustable scanning area

Fully adjustable scanning area ensures that by exposing only the required region, the patient dose is decreased.

True 3-in-1 platform



Cephalometric



Cephalometric PA

DTX STUDIO™ Clinic

The comprehensive X-ray software, DTX Studio Clinic, will be installed with your new device. DTX Studio Clinic unifies the software platform for 2D and 3D diagnostics, opening up a whole new era of digital workflow integration.

Compatible with Windows and Mac operating systems, the DTX Studio Clinic platform will integrate both existing and future devices as well as current software provisions into one unified working process.



Leading the way through the decades

For more than 60 years, the name of ORTHOPANTOMOGRAPH system has stood for ultimate reliability and clinically correct maxillofacial imaging.

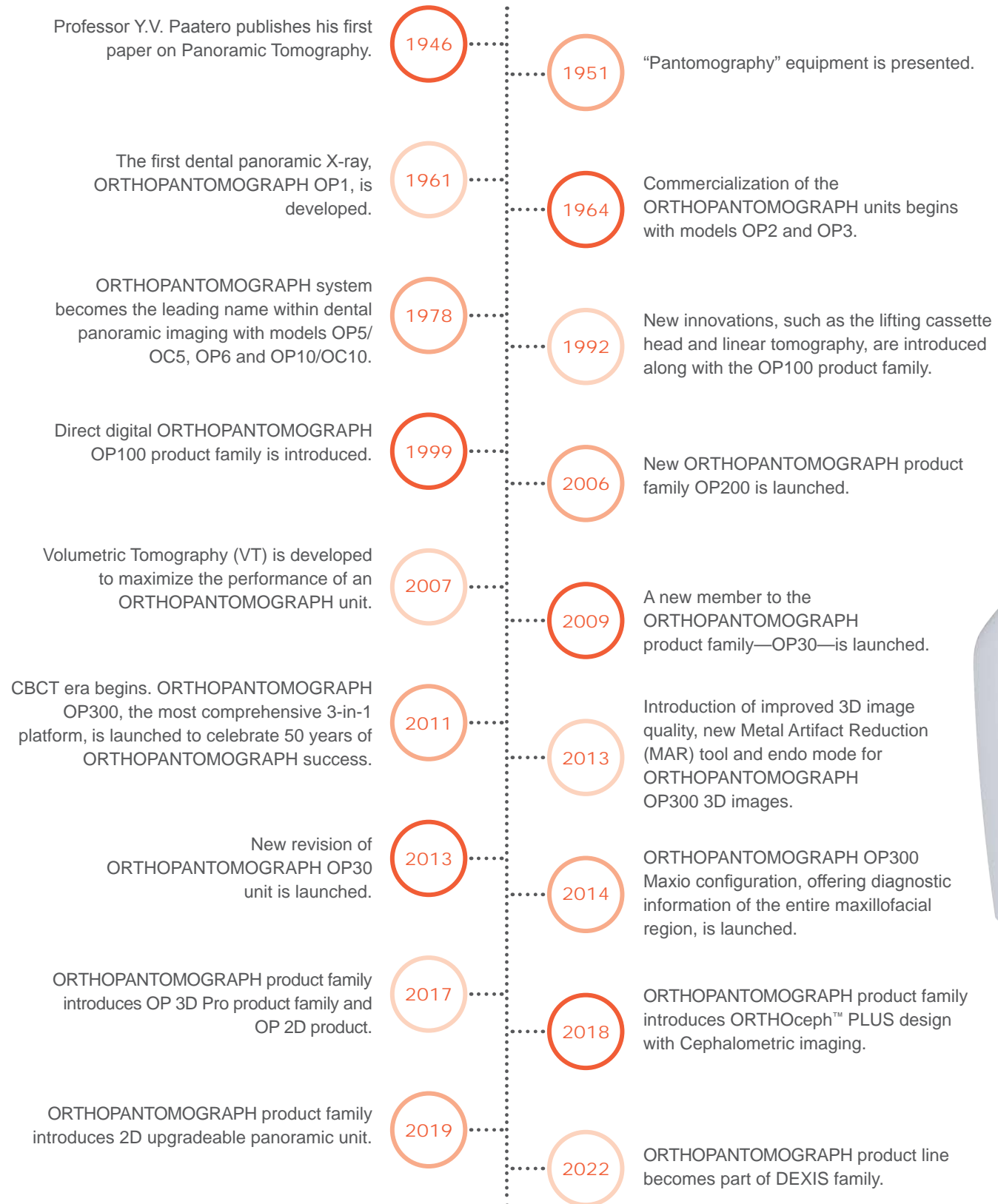

DEXIS—Dental imaging excellence

DEXIS brands are committed to providing the digital foundation so our customers can do more of what is important to them. Through product innovation, world-class service and exceptional support, DEXIS brands brings the best dental technology—from Gendex™, Instrumentarium Dental, NOMAD™ Pro 2, and SOREDEX™—together as one.

DEXIS solutions transform practices and patient smiles. Built on over 200 years of dental imaging expertise, our recognized products are trusted by over 150,000 offices worldwide. Today, DEXIS brands help practices improve patient outcomes with an ever-expanding portfolio of award-winning digital solutions, encompassing breakthrough technologies in CBCT, intraoral digital radiography, intraoral scanning, implant planning, handheld x-ray, and navigated surgery. From our groundbreaking i-CAT™ FLX V-Series and our handheld NOMAD Pro 2 X-ray system to our smart DEXIS Titanium digital sensors, DEXIS brands meets the needs of patient today while preparing your practice for the treatments of tomorrow.

Everyday, we are empowering clinicians to do more of what matters.





Technical specifications

Focal Spot	0.5 mm, IEC 336
Tube Voltage	57-90 kV
Tube Current	3.2-16 mA
HU Capacity	35 kJ, 49 000 HU
Minimum Total Filtration	3.2 mm Al
Wheelchair accessible	Yes

2D	Panoramic	Cephalometric
Image Detector	CMOS	CMOS
Sensor Pixel Size	100 µm	100 µm
Image Pixel Size	100 µm	100 µm
Scan/Exposure Time	8.6-16.1 s	10-20 s
Image Field Height	148 mm	170 mm–260 mm
Imaging Programs	Standard, Pediatric, Ortho Zone, Orthological, Wide Arch, Lat TMJ, PA TMJ, Maxillary Sinus, Bitewing	
Weight	200 kg/440 lbs	250 kg/551 lbs

3D	OP 3D Pro
Image Detector	CMOS
Image Voxel Size	85 µm-420 µm
Scan Time	11-42 s
Exposure Time	1.2-8.7 s
Image Volume Sizes (HxW)	50x50, 61x78, 78x78, 78x150, 130x150 mm
DICOM Support	Yes
Min. room height	2050-2450 mm

Minimum System Requirements for 3D Acquisition Workstation

CPU (processor)	Intel Core i5, i7 or Xeon, 4-cores or more
GPU (graphics processing unit)	NVIDIA Quadro M2000 4GB or GeForce GTX 1050 Ti 4GB
RAM (memory)	8 GB or more
Storage (hard disk)	1 TB or more RAID 1 or RAID 5 recommended for data redundancy, plus backup
Network	Gigabit Ethernet 1000 Mb/s
Operating System	Windows 10 Pro or Enterprise, 64-bit Windows 8.1 Pro or Enterprise, 64-bit Windows 7 Professional, Ultimate or Enterprise, 64-bit, with SP1
Display	1920x1080 resolution (Full HD) or higher, at least 300 cd/m2 brightness for typical room lighting, native contrast ratio 100:1 or better, 8-bit panel strongly recommended
Other	OpenCL 1.1 support DVD-ROM drive Anti-virus software
Notes	Please refer to software and device installation manuals for detailed requirements

Unit Dimensions

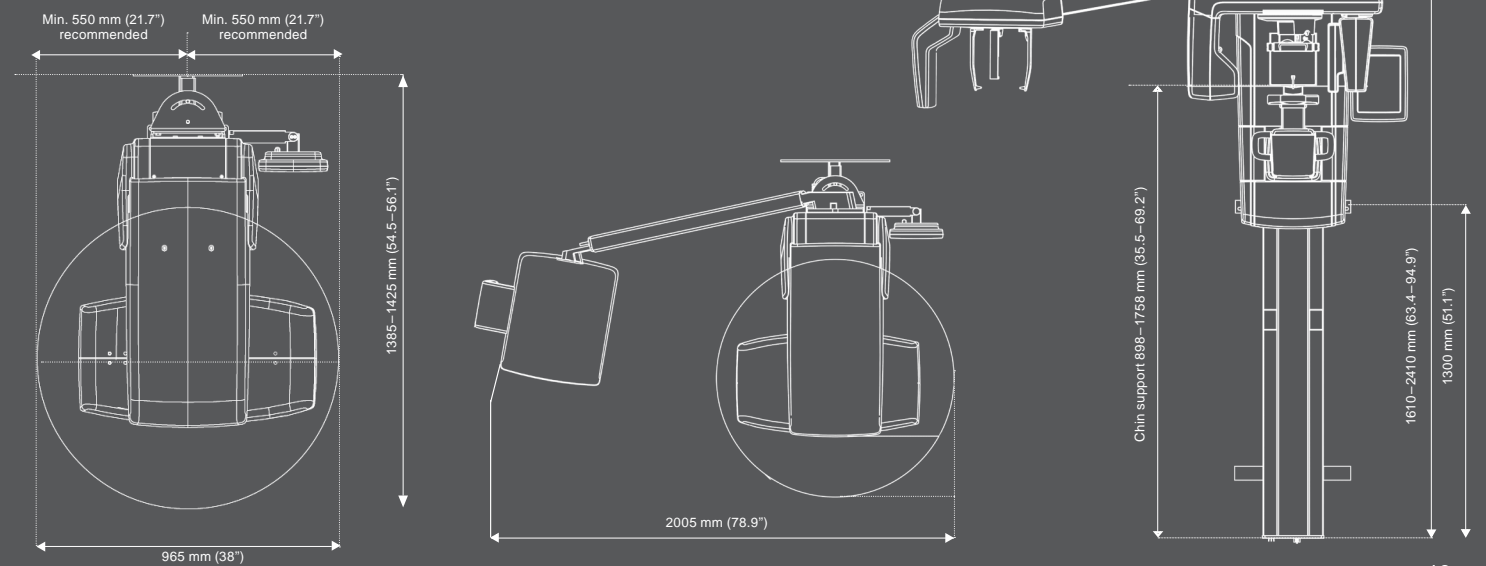

About DEXIS

DEXIS innovation is nothing new. After all, our recognized, trusted products are built on over 200 years of dental imaging expertise, combining leading brands including i-CAT™, Gendex™, Instrumentarium, SOREDEX™, and NOMAD™ Pro 2. Today, over 150,000 offices trust DEXIS products around the world.

DEXIS now includes a full portfolio of products including CBCT and intraoral scanners, our legacy digital sensors and handheld x-ray system and DTX Studio™ Clinic, the next generation software. This complete digital solution works seamlessly together as well as with other systems to enhance the way you diagnose, plan, and treat patients in your practice. Elevate your patient outcomes with greater confidence — across the patient journey. With DEXIS proven solutions, you'll be able to treat patients from consultation to diagnosis to treatment to surgery and deliver appliances, all with the efficiency that you come to expect with the DEXIS brand you already know.

DEXIS | 450 Commerce Drive | Quakertown PA 18951 | USA | 1-888-88-DEXIS | DEXIS.com

The products, equipment and services illustrated and described in this brochure reflect knowledge at the time of printing. Dental Imaging Technologies Corporation accepts no liability for any deviation from the illustrations in terms of color or shape, or any errors or print errors, and retains the right to make changes to the brochure at any time. Full or partial reprinting is only permitted with permission from Dental Imaging Technologies Corporation. For indications for use, please visit: DEXIS.com

Dental Imaging Technologies Corporation reserves the right to make changes to specifications and features shown herein, or to discontinue the product described at any time without notice or obligation. Contact your local authorized representative for the most current information. Manufactured by Palodex Group OY, Nahkelantie 160, FI-04300 Tuusula, Finland. Tel. +358 10 270 2000
© Dental Imaging Technologies Corporation. All rights reserved. DX00306/RevA