



iQuest

STANDARD • HOSPITAL • LOUNGE

Update : September 2018





In 10 years, the Quest examination couch has satisfied more than 15,000 healthcare professionals. General practitioners, cardiologists, dermatologists and physiotherapists from over 70 countries have come to appreciate

the French quality of this robust, comfortable and easy to access examination couch. Five years ago, Promotal conducted the largest survey ever performed in Europe and the Middle East. This 3-year study, carried out in collaboration with more than 200 health professionals, revealed 3 basic needs: equal treatment of people with mobility limitations, efficiency in carrying out medical examinations and user-friendly equipment. iQuest is Promotal's new revolution. We have designed an examining couch with a sleek, lightweight design that will improve your comfort and that of your patients thanks to the low position that is the lowest on the market, the programmable positions and the autonomous movements that are 2 times faster.



EQUAL TREATMENT

MAKE THINGS EASIER FOR YOUR PATIENTS WITH MOBILITY LIMITATIONS :

- > Low 46 cm position provides easier access for patients
- > Patients can use the raised backrest for support when getting on the couch
- > Safe, smooth electrical movements

EXAMINE ALL YOUR PATIENTS EASILY :

- > Accommodates up to 250 Kg
- > Superior comfort with the Lounge upholstery



EFFICIENT DESIGN

YOUR EXAMINATIONS WILL GO SMOOTHLY THANKS TO

- > Movements that are 2 times faster
- > The intuitive position of the patient on the Lounge upholstery
- > The autonomous movements: Press once to change positions
- > The intuitive controls and the pre-programmed patient access position



USER-FRIENDLY DESIGN

CHANGE POSITIONS EFFORTLESSLY :

- > All-electric examination couch: Height, backrest, Trendelenburg / reverse Trendelenburg
- > Variable height from 46 to 93 cm
- > 2 programmable positions, 100% configurable
- > Intuitive controls built into the backrest (Lounge model)

IMPROVE YOUR PATIENTS' COMFORT THANKS TO :

- > The superior comfort Lounge upholstery



ACCESS



EXAMINATION



HIGH POSITION



TRENDELENBURG



REVERSE TRENDELENBURG

3 MODELS,
3 NEEDS.

● OPTIONS
● ACCESSORIES



Face cut-out
65cm Ref. 2231-65
75cm Ref. 2231-75

Factory-installed
upholstery
Ref. 600000-01

Battery
Ref. 3092-01



iQuest STANDARD

Ref. 3050-40
With retractable wheels
Ref. 3050-50
Upholstery width 65 cm
Ref. 600150-65
Upholstery width 75cm
Ref. 600150-75



Circuit breaker
Ref. 3058-01

Cable reel
Ref. 3032-01XX

Anti-static wheels
Ref. 3031-01

Integrated plug
EU-US-UK Ref. 30400-01

Equipotential plug
Ref. 2059-01



iQuest LOUNGE

Ref. 3055-20



Clamp
Ref. 166

Pair of clamps on rail
Ref. 878-12

Pair of legrests
Ref. 840

Pair of legrest covers
Ref. 861

Pair of stirrups
Ref. 850



iQuest HOSPITAL

Ref. 3050-60



IV pole with 2 hooks
Ref. 985-01

Auto-locking IV pole
with 2 hooks
Ref. 2985-01

Armrest
(one)
Ref. 2536

Armrest cover
(one)
Ref. 2537

Lounge headrest
Ref. 30679-01



Flat upholstery headrest
Ref. 1102-10

Adjustable paper roll
holder
Ref. 2056-02

Backrest extension
Ref. 2055-01

Wired foot control
Ref. 3051-10

Plastic cover (foot end)
for flat upholstery
65cm Ref. 600150-65C
75cm Ref. 600150-75C



Plastic cover
(head end)
Ref. 3056-02

Plastic cover
(foot end)
Ref. 3056-01

Pair of barriers
Ref. 85114-01

Pair of head rails
Ref. 30878-XXT

Pair of foot rails
Ref. 30878-XXP

iQuest

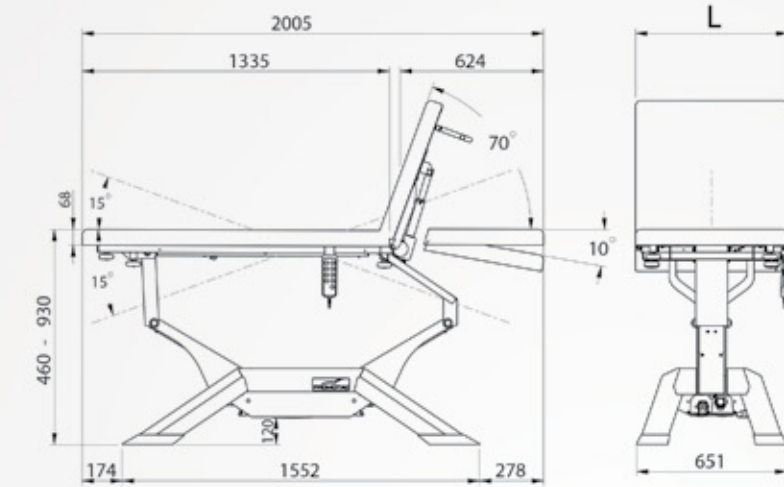

STANDARD

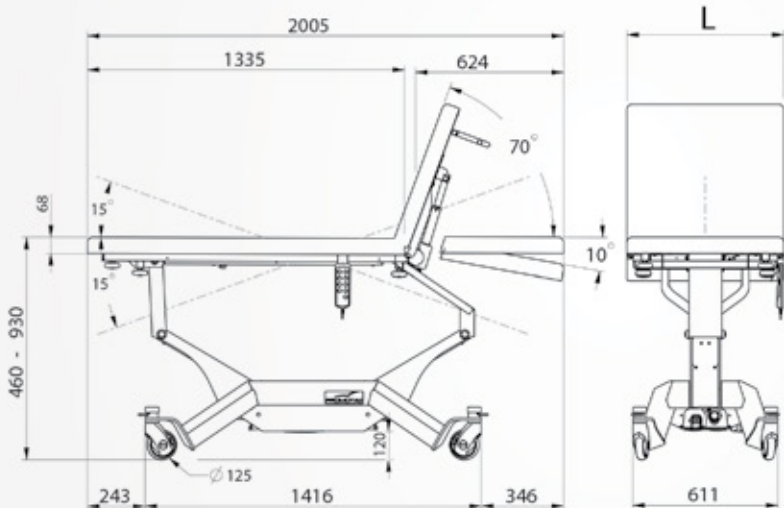



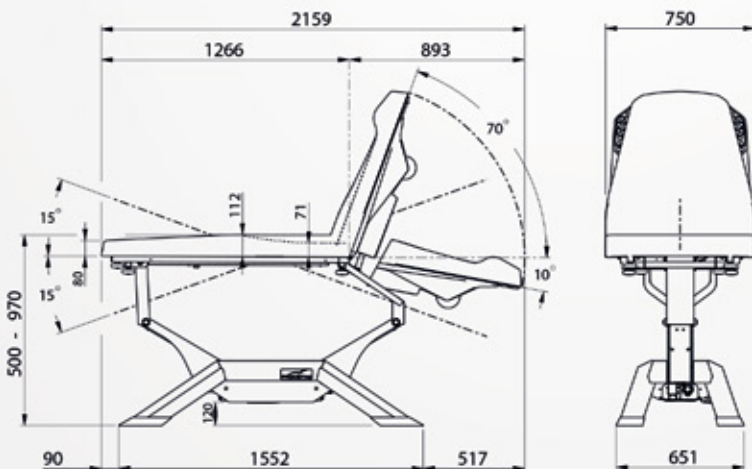















HOSPITAL



LOUNGE

COLORS OF UPHOLSTERIES & COUNTERPLATES

- | | | |
|-------------------|---|---------|
| 32 - BLUE * |  | CLASSIC |
| 93 - COTTAGE * |  | |
| 35 - RED * |  | |
| 34 - YELLOW * |  | |
| 91 - WHITE |  | |
| 92 - MARINE * |  | VITAMIN |
| 56 - DARKNESS |  | |
| 57 - ANTISTATIC |  | |
| 64 - GRAPE |  | |
| 67 - LAGOON |  | |
| 66 - SWEET * |  | COSY |
| 63 - CEDRAT |  | |
| 80 - SKY |  | |
| 81 - SEA GREEN * |  | |
| 65 - LILAC * |  | |
| 96 - TIN * |  | |
| 82 - MOUSE GREY * |  | |
| 83 - NATURAL |  | |
| 84 - CHOCOLATE * |  | |

*Colors benefiting from a matching counterplate. The other colors are equipped with a white counterplate



Distributed by:



PROMOTAL.NZ
PROMOTAL.COM.AU